

Scandinavian Business Seating AS

Sundveien, N-7374 Røros, Norway

Fürth, 28.11.2014

Test report no. FUHLFP2014-10161

Receipt of sample: 07.11.2014; period of investigation: 07.11.2014 – 28.11.2014

Overall laboratory management: Kerstin Scharrer / Hardlines Laboratory: Adem Durmaz

The reproduction of extracts or any other kind of partial replication of the test report is only permitted with the consent of the commissioned laboratory. This test report consists of 31 page(s) and refers exclusively to the test item(s). The test methods that are identified with *) are not listed on the appendix to the certificate of accreditation. ¹⁾ Issuing date bilingual report

Test item: "HÅG Capisco Puls 8020" Office work chair

Test General safety tests for the obtaining of the GS-Certificate

Determination:

Essential components of the tests were the safety, functionality, fitness-for-use and ergonomic properties. Basis of the tests were the following references: EN 1335, part 1, part 2 and part 3, DIN 4550 and considering the current state of the art of technique and ProdSG.

The reference models "HÅG Capisco Puls 8020" was tested standing in for the complete office work chair model range "8010" and "8020".

Notes:

1. Please refer to the following pages for technical characteristics and results as well as detailed test conditions and requirements.
2. The office work chairs comply with type A of EN 1335, part 1. Thus the requirements for ergonomic design of the EU-Display Workstation Degree as laid out in DIN EN ISO 9241, part 5, ed.08.1999 are met.
3. The accessibility and selection of materials did not result in suspicion regarding a PAH-risk (see document ZEK 01.01-08 of ZLS), see page 30¹⁾.

Intertek Consumer Goods GmbH
Hardlines Testing Laboratory

Reviewed by:



Adem Durmaz
Director – Hardlines

Revised by:



Anh Vu Nguyen
Senior Engineer – Hardlines

Product identification:

Test sample: Office work chair
Model name: "HÅG Capisco Puls 8020"
Item number: 8010, 8020
Manufacturer: Scandinavian Business Seating AS
7366 Røros, Norway
Number of test samples: 1 piece
Distributor: Scandinavian Business Seating AS
Distributor's item number: ./.
Distributor's PO number: ./.
Delivered on: 07.11.2014
Delivered by: Scandinavian Business Seating AS

Product documents:

- Consideration of test report 21160480_001 of TÜV Rheinland
- Consideration of GS-Certificate S 60037303-0001
- Consideration of gas spring certificate "Bauart geprüft" of TÜV Rheinland no. 62723
- PAH evaluation sheet FUHLFP2014-14333-PAH

Scope of the investigations:

General test and safety requirements according to

- EN 1335-1:2000 – Office furniture –
Office work chair – Part 1: Dimensions; Determination of dimensions
- EN 1335-2:2010 – Office furniture –
Office work chair – Part 2: Safety requirements
- EN 1335-3:2009 – Office furniture –
Office work chair – Part 3: Test methods
- ZEK 01.01-08 of ZLS – PAH risk

Key to findings

P = passed
F = failed
n.a = not applicable

Applicability of measurements:

The test results refer only to the objects to be tested. The digital images in this report are intended as supplementary information and are not an integral part of this test report.

Measurement uncertainty:

Unless otherwise indicated, all measured dimensions are accurate in accordance with DIN 7168-g for old structures and in accordance with DIN ISO 2768 part 1 "c" for new structures. For all other physical measurement values, the uncertainty range is < 5 %. Testing was done in standard climate conditions of 23°C / 50% relative humidity.

Test equipment list

The test equipment list contains a list of the measuring tools used and measuring equipment, gauges, templates and load weights that were used in accordance with the scope of the investigations.

Testing machines and devices as well as any connections that are necessary for the performance of tests are not an integral part of the test equipment list.

The following test equipment were available for testing in accordance with the scope of the investigations:

Clause	Test equipment	Equipment no.
General tests	Ruler	PM_HL_18.321
General tests	Band ruler 3000 mm	PM_HL_18.367
General tests	Calliüer	PM_HL_17.044
Strength and durability tests	Load cell 5 kN	PM_HL_18.358
Strength and durability tests	Load cell 5kN	PM_HL_18.359
Strength and durability tests	Load cell 5kN	PM_HL_18.360
Strength and durability tests	Load cell 5 kN	PM_HL_18.361
Strength and durability tests	Load cell 2 kN	PM_HL_18.362
Strength and durability tests	Load cell 5,5 kN	PM_HL_18.363
Strength and durability tests	Seat dummy	PM_HL_18.199
Stability	Pull-Push-Gauge	PM_HL_17.026
Stability	Stability Table	PM_HL_18.107
Stability	Load disc 10 Kg	PM_HL_18.231
Stability	Load disc 10 Kg	PM_HL_18.232
Stability	Load disc 10 Kg	PM_HL_18.233
Stability	Load disc 10 Kg	PM_HL_18.234
Stability	Load disc 10 Kg	PM_HL_18.235
Stability	Load disc (wood)	PM_HL_18.216
Stability	Load disc (wood)	PM_HL_18.217
Stability	Load disc (wood)	PM_HL_18.218
Stability	Load disc (wood)	PM_HL_18.219
Stability	Load disc (wood)	PM_HL_18.220
Stability	Load disc (wood)	PM_HL_18.221
Stability	Load disc (wood)	PM_HL_18.222
Stability	Load disc (wood)	PM_HL_18.223
Stability	Load disc (wood)	PM_HL_18.224
Stability	Load disc (wood)	PM_HL_18.225
Stability	Load disc (wood)	PM_HL_18.226
Loading point template - A-B	Measurement template	PM_HL_18.109
Strength and durability tests	Durability test stand	PM_HL_18.153
Strength and durability tests for castor	Linear axis test stand	PM_HL_18.066

General Testing

Technical characteristics

General dimensions (measurements in mm)

Depth:	530
Height:	940
Width:	565
Net weight:	11.4 kg

Brief description of the sample

- Seat height adjustable by means of gas spring from S.C. Stabilus Romania S.R.L.
- Denomination of gas spring: DIN 4550-4, class 4, valid until 31.12.2017
- Seat mechanism with synchronous system
- Initial tension adjustable by means of hand wheel
- Sliding seat adjustable in 7 positions by hand lever
- Seat inclination lockable by hand lever
- Seat plate made of plastic (PP)
- Seat padded and upholstered
- Fixed backrest with adjustable lumbar support in height, available in different design, in low version and high version with headrest
- Backrest covered with network, leather or only with backrest pads
- Armrest adjustable in height and width
- Arm pads inclination adjustable
- Base made of aluminium die cast
- 5 brake unloaded twin wheel swivel castors type "H" or "W"
- Denomination of castors: GR
- Castor manufacturer: Guy Raymond
- The differences between the "H09" models are only at the backrest heights

Product pictures: "HÅG Capisco Puls 8020"



Pic.1: Front view



Pic.2: Side view



Pic.3: Back view



Pic.4: Bottom view

Product pictures: "HÅG Capisco Puls 8020"

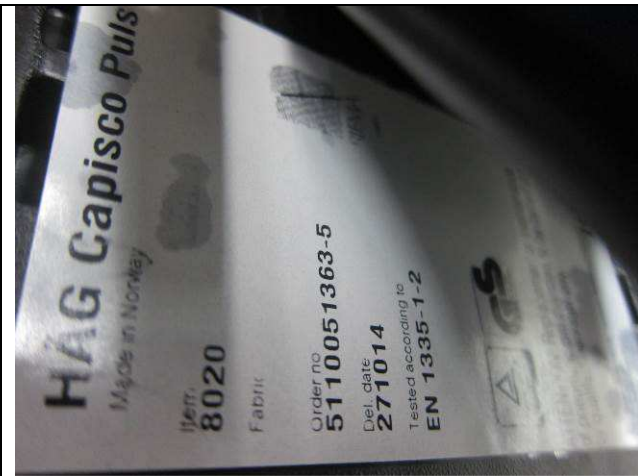

Pic.5: Base system



Pic.6: Adjustment levers



Pic.7: Castor



Pic.8: Back column

Technical testing

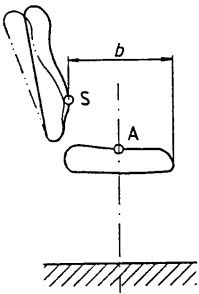
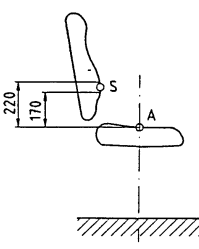
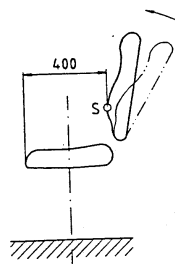
Test characteristics/requirements	Test parameters/results	Findings
<p>Dimensions in accordance with EN 1335-1:2000</p> <p>The chair shall provide support to the thighs and the lumbar region which sufficient depth and height to provide all users with a sitting position suited to their activity and their height.</p> <p>The dimension of the chair shall comply with one of the types of annex A. An exception is made in the case of the stability dimension t, provided that the chair passes the rearwards stability test according to 5.4.2 and 5.4.3 of EN 1335-3:1999.</p> <p>Determination of reference points</p> <p>The chair shall be positioned on a flat, rigid and horizontal test surface.</p> <p>Point "A"</p> <p>The dummy shall be placed on the seat surface symmetrically to the median plane in such a way that the centre of gravity of the main mass coincides with the axis of rotation. The seat shall be set as close as possible to the horizontal and the back rest shall be set as close as possible to the vertical. The movable mass shall be positioned so that the lower edge of the groove coincides with the vertical line tangential to the front edge of the seat. Before measuring, the seat shall be loaded and unloaded five times for a short period.</p> <p>Back supporting point "S"</p> <p>In the case of chairs with a back rest rotatable around a horizontal axes the upper and lower edges of the back rest shall be positioned vertically one above the other midway in the median plane before measurements are made. If this is not possible the closest possible position to it shall be chosen.</p>	  	

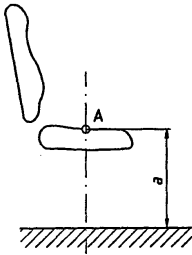
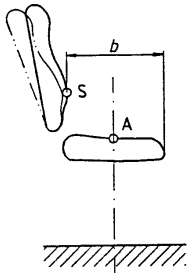
Test characteristics/requirements	Test parameters/results	Findings
<p>Determination of dimensions</p> <p>The chair shall be positioned on a flat, rigid and horizontal test surface. The seat shall be set as close as possible to the horizontal and the back rest shall be set as close as possible to the vertical. Linear dimensions shall have an accuracy of ± 2 mm and all angles an accuracy of $\pm 1^\circ$.</p> <p>Unless otherwise specified, all dimensions shall be measured loading at the measurement point. Where point "A" is used as reference point the seat shall be loaded by the dummy in accordance with 5.1.</p> <p>All adjustable dimensions and angles shall be measured both in the smallest and largest position.</p> <p>Seat height [a]</p> <p>The seat height [a] is the vertical distance between the floor and the point "A"</p> <p>NOTE: The height is determined by measurement, either at the front edge of the seat in combination with the slope of the dummy or directly at point "A".</p> <p>Seat depth [b]</p> <p>The seat depth [b] is the horizontal distance from the front edge of the seat to the vertical projection of the back supporting point "S", measured in the median plane.</p> <p>Before determining the seat depth of chairs with height adjustable back rests, the back supporting point "S" shall be set at a height of 220 mm above point "A". If the seat depth and back rest are adjusted simultaneously, i.e. when the seat depth is increased, the back rest height is automatically increased, the minimum seat depth shall be measured with back rest in its lowest position, and the maximum seat depth with the back rest in its highest position.</p>	 	

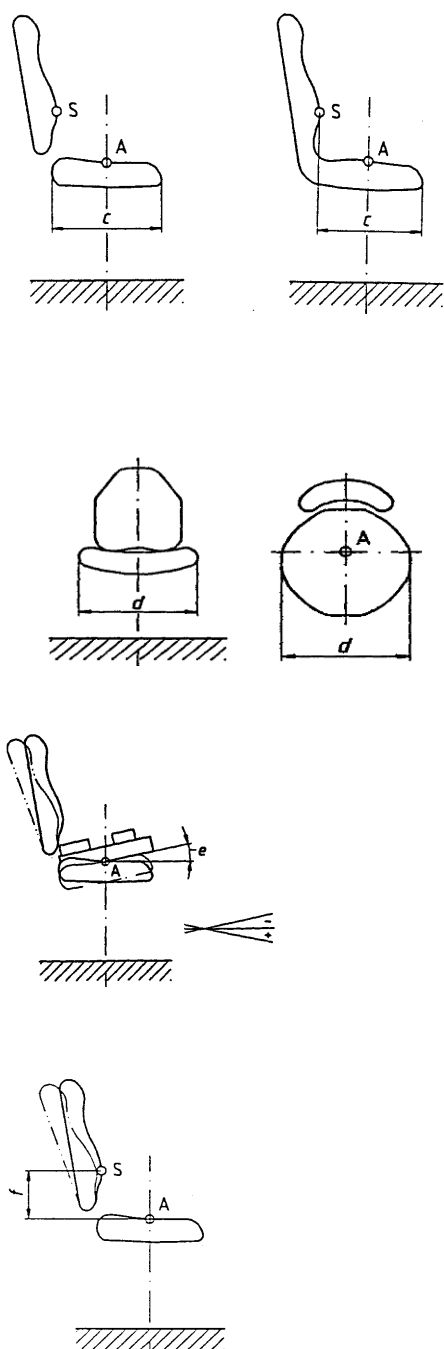
Test characteristics/requirements	Test parameters/results	Findings
<p>Depth [c] of seat surface</p> <p>The depth [c] of seat surface is the maximum horizontal distance between vertical lines through the front and rear edges of the seat surface.</p> <p>If the shape of the seat makes it impossible to define a rear edge, the maximum horizontal distance shall be measured from the rear of the seat surface below the back supporting point "S" (see 3.6) to the front edge of the seat surface. The measurement shall be carried out with the backrest set to the forward tilt.</p> <p>Seat width [d]</p> <p>The seat width [d] is the horizontal distance between vertical lines through the side edges of the seat surfaces measured in the transverse plane.</p> <p>Inclination [e] of seat surface</p> <p>The inclination [e] of the seat surface is the angle in the median plane between the lower edge of the dummy and a horizontal line. Rearwards slope is designated "-" otherwise "+".</p> <p>Height [f] of the back supporting point "S" above the seat surface</p> <p>The height [f] of the back supporting point "S" above the seat surface is the vertical distance between the point "S" and point "A".</p>		

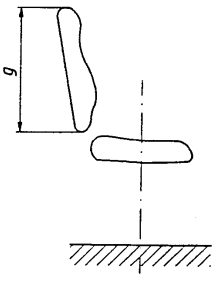
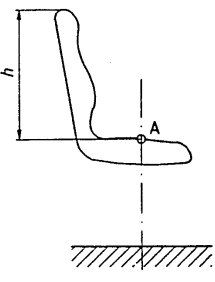
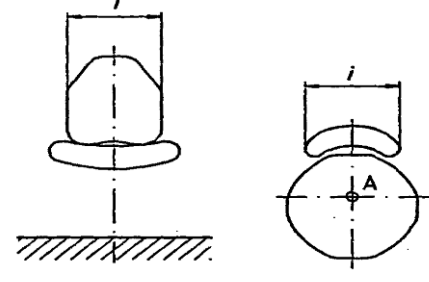
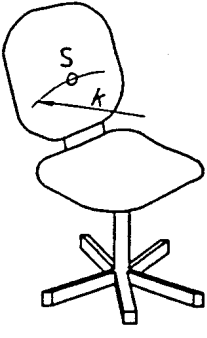
Test characteristics/requirements	Test parameters/results	Findings
<p>Height [g] of the back pad</p> <p>The height [g] of the back pad is the vertical distance between the upper and lower edges of the back pad, measured in the median plane.</p> <p>Height [h] of the upper edge of the back rest above the seat surface</p> <p>The height [h] of the upper edge of the back rest above the seat surface is the vertical distance between the upper edge of the back rest and the point "A" measured in the median plane.</p> <p>Back rest width [i]</p> <p>The back rest width [i] is the maximum horizontal distance between its side edges.</p> <p>Horizontal radius [k] of back rest</p> <p>The horizontal radius [k] of the back rest is the radius measured at the height of the back supporting point "S".</p>	   	

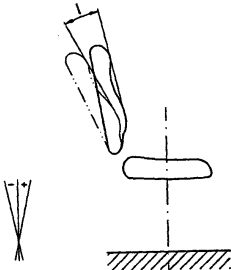
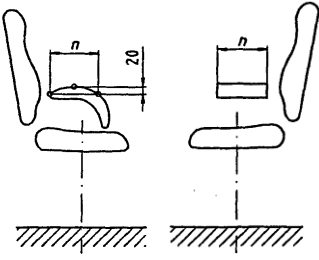
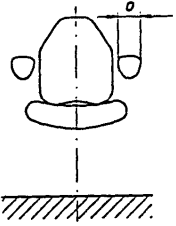
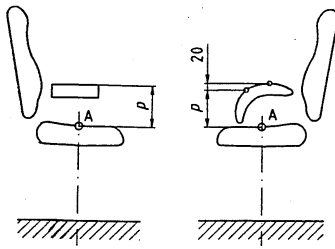
Test characteristics/requirements	Test parameters/results	Findings
<p>Back rest inclination adjustment range [l] ("tilt")</p> <p>The back rest inclination is the angle between the transverse plane and the back rest determined at point "S". Rearwards slope is designated "-" otherwise "+".</p> <p>The back rest inclination adjustment range [l] is the angle between the foremost and the rearmost position of the inclined back rest.</p> <p>Length [n] of the useful area of the arm rest</p> <p>The length [n] of the useful area of the arm rest is the horizontal distance between vertical lines through its front and rear edges.</p> <p>In the case of an arm rest which is not horizontal or which is rounded at the ends or is of non-rigid material, the dimension [n] shall be measured in a plane 20 mm below the highest point of the useful area of the arm rest.</p> <p>Width [o] of the useful area of the arm rest</p> <p>The width [o] of the useful area of the arm rest is the horizontal distance between vertical lines through the inner and outer edges of the arm rest.</p> <p>If the shape of the arm rest does not allow for an exact measurement of this width, it shall be measured 20 mm below the top edge.</p> <p>Height [p] of the useful area of the arm rest above the seat</p> <p>The height [p] of the useful area of the arm rest above the seat is for horizontal arm rests the vertical distance between the upper surface of the arm rest and point "A".</p> <p>In the case of an arm rest which is not horizontal or which is rounded at the ends or is of non-rigid material, the dimension [p] is the vertical distance between the horizontal plane 20 mm below the highest point of the arm rest and point "A".</p>	   	

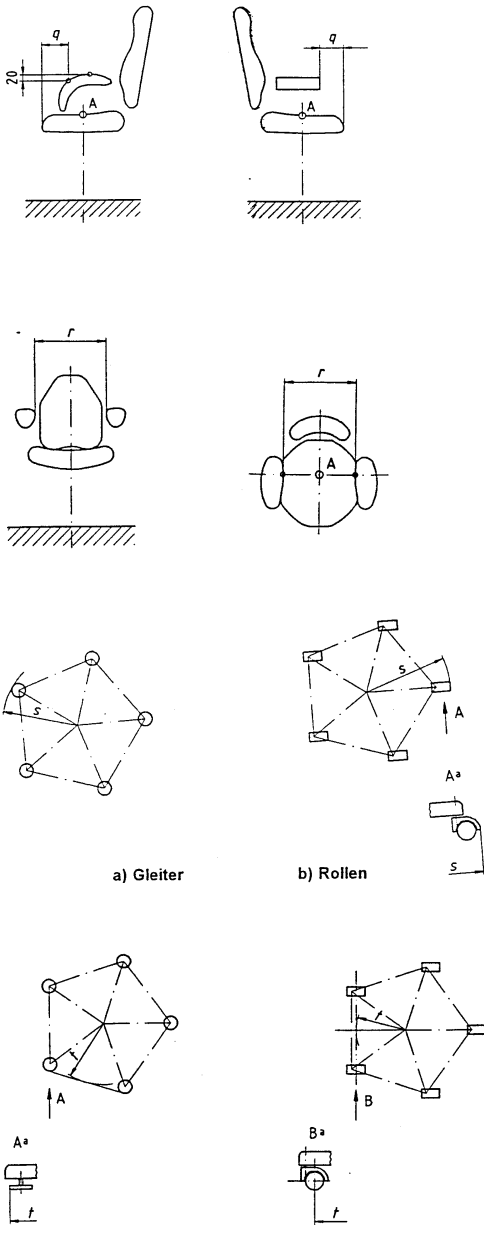
Test characteristics/requirements	Test parameters/results	Findings
<p>Distance [q] from the front of the useful area of the arm rests to the front edge of the seat</p> <p>The distance [q] from the front of the useful area of the arm rests to the front edge of the seat surface is the horizontal distance between the front edge of the arm rests and a line extended vertically above the front edge of the seat surface in the median plane.</p> <p>Clear width [r] between the useful area of the arm rests</p> <p>The clear width [r] between the useful area of the arm rests is the horizontal distance between vertical lines through the inner edges of the arm rests, measured in the transverse plane.</p> <p>Maximum offset [s] of the underframe</p> <p>The maximum offset [s] of the underframe is the maximum between the outermost point of the underframe including castors or glides and the axis of rotation.</p> <p>Stability dimension [t]</p> <p>The stability dimension [t] is the smallest distance between the overbalancing axes on the floor and the axes of rotation of the chair. Where castors are used, the most unfavourable castor position shall be used for the measurement.</p>	 <p>a) Gleiter</p> <p>b) Rollen</p>	

Dimension table for Office work chair "HÅG Capisco Puls" 8020 – TYPE "A"

Dimensions	Symbol	Adjustability	Type A				Actual value	Results
			allowed (-)	Min. [a]	Max. [a]	allowed (+)		
Office work chair:			allowed (-)	Min. [a]	Max. [a]	allowed (+)		
Seat height ^{b)}	[a]	adjustable	yes	400	510	yes	392 – 525 mm	P
		adjustable range	no	120	+	yes		
Seat depth	[b]	fixed		./.	./.		399 – 439 mm	P
		adjustable	yes	400	420	yes		
		adjustable range	no	50	+	yes		
Depth of seat surface	[c]		no	380	+	yes	410-415 mm	P
Seat width	[d]		no	400	+	yes	440-460 mm	P
Inclination of seat surface	[e]	fixed		./.	./.		-3.8° to -19,2°	P
		adjustable	yes	-2	-7	yes		
		adjustable range	no	6°	+	no		
Height of the back Supporting point "S" above the seat surface	[f]	fixed		./.	./.		127 – 222 mm	P
		adjustable	yes	170	220	yes		
		adjustable range	no	50	+	yes		
Height of the back pad - adjustable in height - non-adjustable in height	[g]		no	220	+	yes	399 mm	P
			no	260	+	yes		
Height of the upper edge of the back rest above the seat surface	[h]		no	360	+	yes	381-471 mm	P
Back rest width	[i]		no	360	+	yes	470 mm	P
Horizontal radius of the back rest	[k]		no	400	+	yes	400 mm	P
Back rest inclination	[l]	adjustable range	no	15°	+	yes	17.8°	P
Length of arm rest	[n]		no	200	+	yes		n.a.
Width of arm rest ^{c)}	[o]		no	40	+	yes		n.a.
Height of arm rest above the Seat	[p]	fixed	no	200	250	no		n.a.
		adjustable	yes	200	250	yes		n.a.
Distance from the front of the arm rest to the front edge of the seat surface ^{d)}	[q]		no	100	+	yes		n.a.
Clear width between the arm rests ^{e)}	[r]		no	460	510	no	n.a.	n.a.
Maximum offset of the underframe (anti-stumbling –dimension)	[s]		yes	+	365 [f]	no	373 mm	P
Stability dimension ¹⁾	[t]		no	195	+	yes	242 mm	P

a) For adjustable functions the Min. and Max. values must be obtained.

b) The minimum range of adjustment is suitable for working surface heights between at least 680 mm and 780 mm. For some part of the user group a foot rest is required.

c) The requirement applies over the minimum value n (See clause 6.13).

d) The requirement applies from a height of 170 mm above point "A" (See clause 6.15).

e) The requirement applies to $\frac{3}{4}$ of the seat depth b (Measured from the front edge of the seat) with the back rest in its foremost position (see clause 6.16).

f) If swivel castors are fitted the requirement is 415 mm.

g) X is the maximum horizontal distance between parts of the upper part of the chair and the axis of rotation (see clause 6)

+ No determination

¹⁾ by tilt mechanism, + 68 mm separate way of sliding seat

Test characteristics/requirements	Test parameters/results	Findings
<p>Safety requirements in accordance to EN 1335-2</p> <p>General design requirements</p> <p>Corners and edges, trapping, pinching and shearing</p> <p>The chair shall be so designed as to minimise the risk of injury to the user.</p> <p>All parts of the chair with which the user comes into contact during intended use, shall be so designed that physical injury and damage to property are avoided.</p> <p>These requirements are met when:</p> <p>a) the safety distance of accessible movable parts is either ≤ 8 mm or ≥ 25 mm in any position during movement;</p> <p>b) accessible corners are rounded with minimum 2 mm radius;</p> <p>c) the edges of the seat, back rest and arm rests which are in contact with the user when sitting in the chair are rounded with minimum 2 mm radius;</p> <p>d) the edges of handles are rounded with minimum 2 mm radius in the direction of the force applied;</p> <p>e) all other edges are free from burrs and rounded or chamfered;</p> <p>f) the ends of accessible hollow components are closed or capped.</p> <p>Adjusting devices</p> <p>Movable and adjustable parts shall be designed so that injuries and inadvertent operation are avoided.</p> <p>It shall be possible to operate the adjusting devices from sitting position in the chair.</p> <p>Connections</p> <p>It shall not be possible for any load bearing part of the chair to come loose unintentionally.</p>	<p>requirements fulfilled</p> <p>no risk of injury</p> <p>fulfilled</p> <p>requirements fulfilled</p> <p>fulfilled</p> <p>fulfilled</p> <p>requirements fulfilled</p> <p>fulfilled</p>	<p>P</p> <p>P</p> <p>P</p> <p>P</p> <p>P</p> <p>P</p>

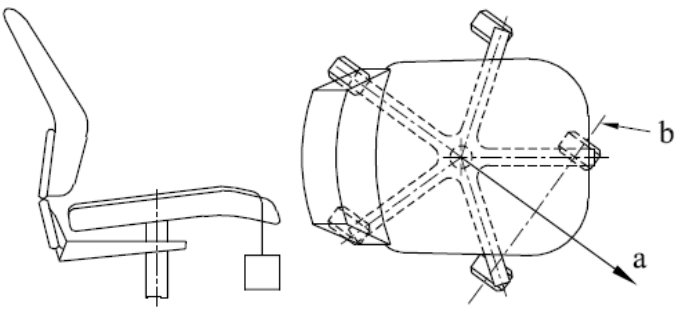
Test characteristics/requirements	Test parameters/results	Findings
<p>Avoidance of soiling</p> <p>All parts which are lubricated to assist sliding (greasing, lubricating, etc.) shall be designed to protect users from lubricant stains when in normal use.</p> <p>Stability during use</p> <p>The chair shall not overbalance under the following conditions:</p> <ul style="list-style-type: none"> a) by pressing down on the front edge of the seat surface in the most adverse position; b) by leaning out over the arm rests; c) by leaning against the back rest; d) by sitting on the front edge. <p>Requirement a) is fulfilled if the chair does not overbalance when tested according to front edge overturning.</p> <p>Front edge overturning</p> <p>Do not position the chair with the stops against the supporting points (3.5). Fix the strap (5.8) to the chair as shown in Figure 7, i.e. the force is applied at the point on the front edge that is furthest from the axis of rotation, and allow the mass M1 to hang freely (see Figure 7).</p>  <p>a position of the strap on the seat surface b the tilting axis, castors in the most adverse position</p> <p>Figure 7 — Front edge overturning</p>	<p>requirements fulfilled fulfilled</p> <p>requirements fulfilled</p> <p>no overbalancing</p> <p>no overbalancing</p> <p>no overbalancing</p> <p>no overbalancing</p>	<p></p> <p>P</p> <p>P</p> <p>P</p> <p>P</p>

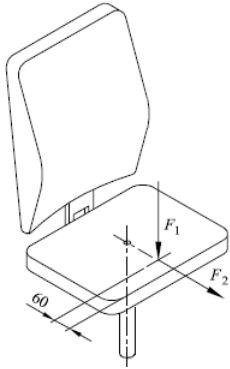
Test characteristics/requirements	Test parameters/results	Findings
<p>Requirements b) and d) are fulfilled if the chair does not overbalance when tested according to forwards overturning and forwards overturning for chairs with footrest.</p> <p>Forwards overturning</p> <p>Position the chair with two adjacent supporting points on the front against the stops.</p> <p>Apply by means of the stability loading device a vertical force F1 acting 60 mm from the front edge of the load bearing structure of the seat at those points most likely to result in overturning. Apply for at least 5 s a horizontal outwards force F2 from the point on the seat surface where the vertical force is applied (see Figure 8).</p>  <p>Key F1 vertical force F2 horizontal force</p> <p>Figure 8 — Forward overturning</p> <p>Forwards overturning for chairs with footrest</p> <p>For chairs with footrests repeat the principle of 7.1.2 on the footrest. For round cross section ring shaped footrests, the vertical force F1 shall be applied through the centre of the ring cross section.</p>	<p>requirements fulfilled</p>	

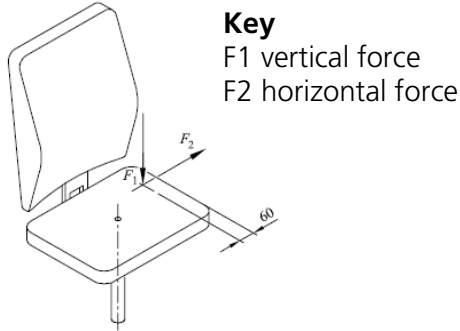
Test characteristics/requirements	Test parameters/results	Findings
<p>Sideways overturning for chairs with and without armrests of EN 1335-3:2009 with the forces and numbers of cycles according to Table A.1 of this standard.</p> <p>Sideways overturning for chairs without armrests</p> <p>Position the chair with two adjacent supporting points on one side against the stops.</p> <p>Apply by means of the stability loading device a vertical force F_1 acting 60 mm from the side edge of the load bearing structure of the seat at those points most likely to result in overturning. Apply for at least 5 s a horizontal sideways force F_2 outwards from the point on the seat surface where the vertical force is applied, (see Figure 9).</p> <div data-bbox="368 965 829 1294" data-label="Image">  <p>Key F_1 vertical force F_2 horizontal force</p> </div> <p>Figure 9 — Sideways overturning for chairs without armrests</p>		

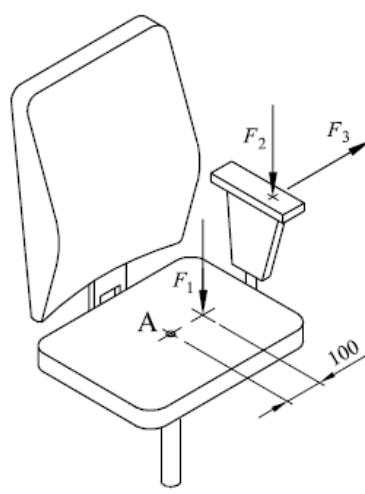
Test characteristics/requirements	Test parameters/results	Findings
<p>Sideways overturning for chairs with armrests</p> <p>Position the chair with two adjacent supporting points on one side against the stops.</p> <p>Apply by means of the stability loading device a vertical force F_1 acting at a point 100 mm from the fore and aft centre line of the seat at the side where the supporting points are restrained (see Figure 10) and between 175 mm and 250 mm forward of the rear edge of the seat.</p> <p>Apply a vertical downward force F_2 acting at points on the arm rest which is on the same side as the restrained supporting points up to a maximum 40 mm inwards from the outer edge of the upper surface of the arm rest, but not beyond the centre of the arm rest, and at the most adverse position along its length. Apply a horizontal sideways force F_3 outwards from the same point for at least 5 s (see Figure 10).</p> <p style="text-align: right;">Dimensions in millimetres</p>  <p>Key A seat loading point F_1 vertical force F_2 vertical force F_3 horizontal force</p> <p>Figure 10 — Sideways overturning for chairs with armrests</p>		

Test characteristics/requirements	Test parameters/results	Findings
<p>The unloaded chair shall not roll unintentionally. This requirement is met when:</p> <ul style="list-style-type: none"> a) the castors are of identical construction; b) the rolling resistance is ≥ 12 N when tested according to Rolling resistance of the unloaded chair. <p>Rolling resistance of the unloaded chair</p> <p>The chair shall be placed on the test surface and shall be pushed or pulled over a distance of at least 550 mm. A speed of (50 ± 5) mm/s shall be maintained over the measuring distance. The force shall be applied at a height of (200 ± 50) mm above the test surface.</p> <p>Record the force used to push or to pull the chair over the distance from 250 mm to 500 mm as the rolling resistance.</p> <p>Requirement c) is fulfilled if the chair does not overbalance when tested according to rearwards overturning for chairs without backrest inclination or Rearwards overturning for chairs with adjustable back rest inclination of EN 1335-3:2009 with the forces and numbers of cycles according to Table A.1 of this standard.</p> <p>Rearwards overturning for chairs without back rest inclination</p> <p>Position the chair with two adjacent supporting points on the back against the stops. When an independent lumbar adjustment is fitted it shall be set in the most adverse configuration.</p> <p>A vertical force F1 shall be applied at point "A" and a horizontal force F2 shall be applied at point "B", (see Figure 11).</p> <p>If the back rest pad is pivoting around a horizontal axis above the height of the seat and is free to move, the horizontal force shall be applied on the axis. If height adjustable, the axis shall be set as close as possible to 300 mm above point "A".</p>	<p>rolling resistance > 12 N</p>	

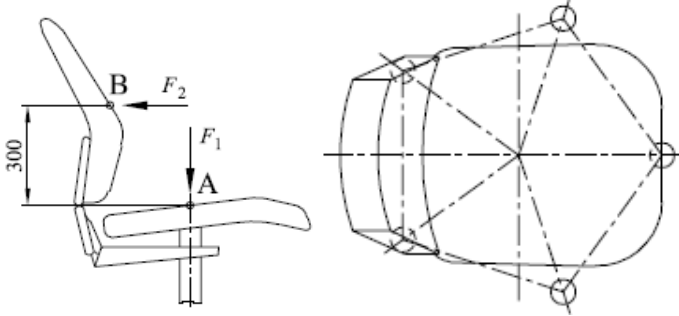
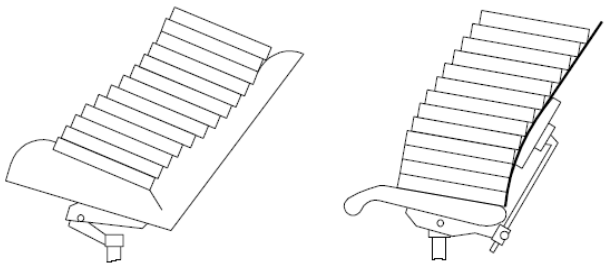
Test characteristics/requirements	Test parameters/results	Findings
 <p>Key</p> <ul style="list-style-type: none"> A seat loading point (6.1) B back loading point (6.2) F₁ vertical force F₂ horizontal force <p>Figure 11 — Rearward overturning for chairs without back rest inclination</p> <p>Rearwards overturning for chairs with adjustable back rest inclination</p> <p>Do not position the chair with the supporting points against the stops. When an independent lumbar adjustment is fitted it shall be set in the most adverse configuration.</p> <p>Load the chair with discs so that the discs are firmly settled against the back rest (see Figure 12). If the height of the stack of discs exceeds the height of the back rest, prevent the upper discs from sliding off by the use of a light support.</p>  <p>Figure 12 — Rearward overturning for chairs with adjustable back rest inclination</p>		

Test characteristics/requirements	Test parameters/results	Findings
<p>Strength and durability</p> <p>The chair shall be constructed to ensure that it does not create a risk of injury to the user of the chair under the following conditions:</p> <p>a) sitting on the seat, both centrally and off-centre;</p> <p>b) moving forward, backwards, and sideways while sitting in the chair;</p> <p>c) leaning over the armrests;</p> <p>d) pressing down on the arm rests while getting up from the chair.</p> <p>These requirements are fulfilled when after the tests specified in Seat front edge static load test, Combined seat and back static load test, Foot rest static load test, Seat and back durability and Armrest durability of EN 1335-3:2009 with the forces and numbers of cycles according to Table A.2 of this standard:</p> <p>e) there are no fractures of any member, joint or component, and</p> <p>f) there is no loosening of joints intended to be rigid, and</p> <p>g) no major structural element is significantly deformed and the chair fulfils its functions after removal of the test loads</p> <p>h) after the test in Arm rest downward static load test – central of EN 1335-3:2009 with the forces and numbers of cycles according to Table A.2 of this standard, the arm rests show no fracture.</p>	<p>requirements fulfilled</p> <p>no risk of injury</p> <p>fulfilled</p> <p>fulfilled</p> <p>no armrest</p> <p>fulfilled</p> <p>fulfilled</p> <p>fulfilled</p> <p>fulfilled</p> <p>fulfilled</p>	<p>P</p> <p>P</p> <p>P</p> <p>n.a.</p> <p>P</p> <p>P</p> <p>P</p> <p>P</p> <p>P</p>

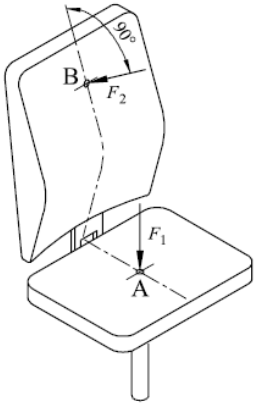
Test characteristics/requirements	Test parameters/results	Findings
<p>Static load tests</p> <p>Position the chair and its components as specified in 4.1 and Table 1 on the test surface.</p> <p>Seat front edge static load test</p> <p>Position the chair and its components as specified in 4.1 and Table 1 on the test surface.</p> <p>Combined seat and back static load test</p> <p>Prevent the chair from moving rearwards by placing stops behind two adjacent supporting points at the rear of the chair.</p> <p>Apply a vertical force F_1 through the seat loading pad at point "A". Keep the seat loaded and apply a force F_2 through the centre of the back loading pad at point "B". When fully loaded the force shall act at $90^\circ \pm 10^\circ$ to the back rest plane (see Figure 13). If the chair tends to overturn reduce the back rest force and report the actual force. Remove the back force and then the seat force.</p>  <p>Key</p> <ul style="list-style-type: none"> A seat loading point (6.1) B back loading point (6.2) F_1 vertical force F_2 perpendicular force <p>Figure 13 — Combined seat and back static load test</p>		

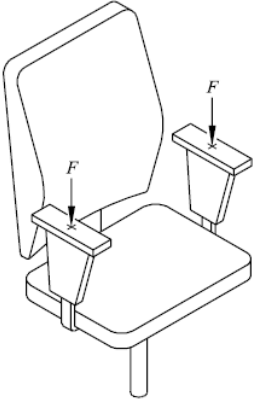
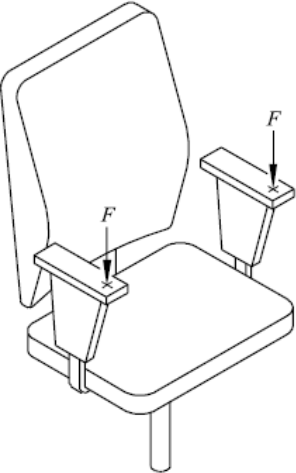
Test characteristics/requirements	Test parameters/results	Findings
<p>Arm rest downward static load test – central</p> <p>The arm rests shall be loaded vertically by means of the local loading pads. The loading points shall be at the mid point of the arm rest length and centred side to side (see Figure 14).</p>  <p style="text-align: right;">Key F vertical force</p> <p>Figure 14 — Armrest downward static load test – central</p> <p>Arm rest downward static load test – front</p> <p>The armrests shall be loaded vertically by means of the local loading pads. The loading points shall be 75 mm from the front edge and centred side to side.</p> <p>Apply the force to both arm rests simultaneously (see Figure 15).</p>  <p style="text-align: right;">Key F vertical force</p> <p>Figure 15 — Arm rest downward static load test – front</p>		

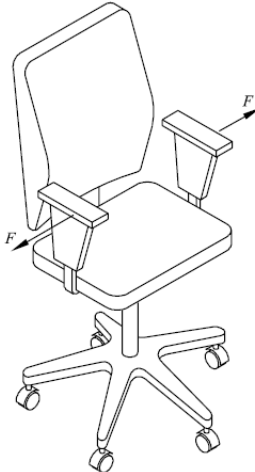
Test characteristics/requirements	Test parameters/results	Findings
<p>Arm rest sideways static load test</p> <p>Apply an outward horizontal force to both armrests simultaneously. Apply the forces to the edge of the arm rest at the point along the arm rest most likely to cause failure but not less than 75 mm from the front or rear edge (see Figure 16).</p> <div data-bbox="167 683 837 1153">  <p>Key F horizontal force</p> </div> <p>Figure 16 — Arm rest sideways static load test</p> <p>Foot rest static load test</p> <p>Apply a vertical force acting 80 mm from front edge of the load bearing structure of the foot rest at those points most likely to cause failure. For round cross section ring shaped footrests, the force shall be applied through the centre of the ring cross section. If the chair tends to overturn load the seat to prevent overturning and report this.</p> <p>Durability tests</p> <p>Position the chair and its components as specified in and Table 1 on the test surface except for the castor and chair base durability test.</p>		

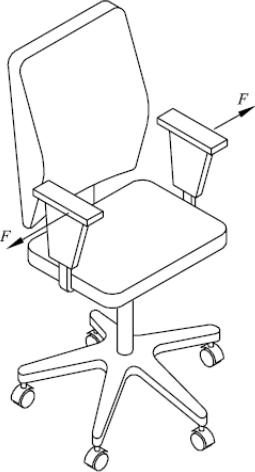
Test characteristics/requirements	Test parameters/results	Findings
<p>Arm rest sideways static load test</p> <p>Apply an outward horizontal force to both armrests simultaneously. Apply the forces to the edge of the arm rest at the point along the arm rest most likely to cause failure but not less than 75 mm from the front or rear edge (see Figure 16).</p> <div style="display: flex; align-items: center;">  <div style="margin-left: 20px;"> <p>Key</p> <p>F horizontal force</p> </div> </div> <p>Figure 16 — Arm rest sideways static load test</p> <p>Foot rest static load test</p> <p>Apply a vertical force acting 80 mm from front edge of the load bearing structure of the foot rest at those points most likely to cause failure. For round cross section ring shaped footrests, the force shall be applied through the centre of the ring cross section. If the chair tends to overturn load the seat to prevent overturning and report this.</p> <p>Durability tests</p> <p>Position the chair and its components as specified in and Table 1 on the test surface except for the castor and chair base durability test.</p>		

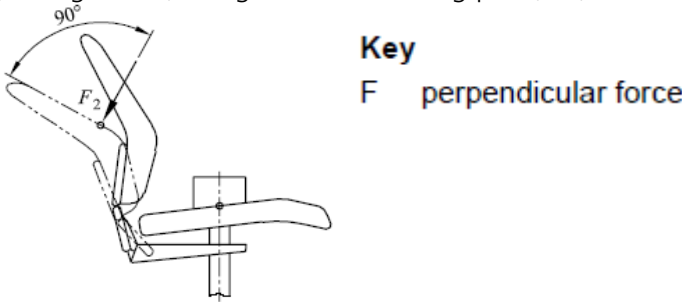
Test characteristics/requirements	Test parameters/results	Findings
<p>Seat and back durability</p> <p>The upper part of the chair shall be positioned so that the centre of the back rest is midway between two adjacent supporting points (3.5) of the base with stops (5.2) against these supporting points.</p> <p>The seat load shall be applied vertically using the seat loading pad (5.3). The back rest force shall be applied at an angle of $90^\circ \pm 10^\circ$ to the back rest when fully loaded (see Figure 17) using the back loading pad (5.6).</p>  <p>Figure 17 — Backrest force application – principle</p> <p>All chairs shall be tested to steps 1 to 5 (see Table 2).</p> <p>Chairs with a locking device(s) for seat and/or back rest angle movements shall be tested in step 2 first with the device(s) locked for half of the cycles and then with the device(s) unlocked for the other half of the cycles.</p> <p>For the first half of the cycles the back rest shall be in the upright position. In steps 3, 4 and 5 the mechanism shall be set free to move.</p> <p>One cycle shall consist of the application and removal of the force(s) at the respective loading point(s).</p> <p>Each step shall be completed before going to the next.</p> <p>First the seat force shall be applied and maintained while the back rest force is applied.</p>		

Test characteristics/requirements	Test parameters/results	Findings												
<p style="text-align: center;">Table 2 — Seat and back durability test</p> <table border="1" data-bbox="347 501 676 873"> <thead> <tr> <th>Step</th> <th>Loading point (see Figure 6)</th> </tr> </thead> <tbody> <tr> <td>1</td> <td>A</td> </tr> <tr> <td>2</td> <td>C-B</td> </tr> <tr> <td>3</td> <td>J-E</td> </tr> <tr> <td>4</td> <td>F-H</td> </tr> <tr> <td>5</td> <td>D-G</td> </tr> </tbody> </table> <p>Armrest durability</p> <p>Apply simultaneously and cyclically the force on each arm rest at points 100 mm behind the foremost point of the arm rest length (see 3.4). Apply a force of (10 ± 5) N through a loading device in principle functioning as shown in Figure 4. With this force applied adjust the apparatus so that each "arm" of the test apparatus has an angle of $10^\circ \pm 1^\circ$ to the vertical. The length of the "arm" of the test apparatus shall be $600 \text{ mm} \pm 10 \text{ mm}$. The arm rests shall be allowed to deform freely.</p> <p>Swivel test</p> <p>The base of the chair shall be secured on a rotating table with a test surface (see 5.1) so that the rotating axis of the chair coincides with the rotating axis of the table. The upper part of the chair shall be loosely fixed in such a way as not to hinder the rotation of the base. Load the seat in loading point A (6.1) with a mass M1 and in loading point C (6.3) with a mass M2 or any equivalent loading which will result in the same downwards force and bending moment on the chair. The angle of rotation shall be 360° at a rate of (10 ± 5) cycles/minute.</p> <p>Change direction after each rotation.</p>	Step	Loading point (see Figure 6)	1	A	2	C-B	3	J-E	4	F-H	5	D-G		
Step	Loading point (see Figure 6)													
1	A													
2	C-B													
3	J-E													
4	F-H													
5	D-G													

Test characteristics/requirements	Test parameters/results	Findings
<p>Footrest durability</p> <p>Using the local loading pad (5.5) apply a vertical downward force to the foot rest at the point most likely to cause failure but not less than 80 mm from the front edge. For round cross section ring shaped foot rests, the force shall be applied through the centre of the ring cross section.</p> <p>Castor and chair base durability</p> <p>This test does not apply to chairs with castors which are braked when the chair is loaded.</p> <p>The chair shall be placed on a rotating table with a test surface (see 5.11) so that the rotating axis of the chair coincides with the rotating axis of the table. Load the seat in point A with M1. The base shall be loosely fixed in such a way that there is no rotation of the base but that the natural movements of the castors during testing are not prevented. The castors shall be left free to swivel, the table shall be rotated with a rate of 6 cycles per minute. The angle of rotation shall be from 0° to 180° and back. One rotation forward and one rotation backward constitutes one cycle.</p> <p>Alternatively attach the chair to a device that provides a linear movement of (1 000 ± 250) mm and a test surface (see 5.11). Load the seat in point "A" with M1. The base shall be loosely fixed in such a way that there is no rotation of the base but that the natural movements of the castors during testing are not prevented. The castors shall be left free to swivel, the device shall move with a rate of 6 cycles per minute. One movement forward and one movement backward constitutes one cycle.</p> <p>NOTE For both alternatives it is recommended to perform the test with a speed as slow as possible with a short break when the device changes direction.</p>		

Test characteristics/requirements	Test parameters/results	Findings
<p>Information for use</p> <p>Each chair shall be accompanied by information for use in the language of the country in which it will be delivered to the end user. It shall contain at least the following details:</p> <p>a) information regarding the intended use;</p> <p>b) information regarding possible adjustments and chair type (see EN 1335-1:2000);</p> <p>c) instruction for operating the adjusting mechanisms;</p> <p>d) instruction for the care and maintenance of the chair;</p> <p>e) information regarding all adjustments;</p> <p>f) information for chairs with seat height adjustments with energy accumulators that only trained personnel may replace or repair seat height adjustment components with energy accumulators;</p> <p>g) information on the choice of castors in relation to the floor surface.</p>	<p>requirements fulfilled</p> <p>available</p> <p>available</p> <p>available</p> <p>available</p> <p>available</p> <p>available</p> <p>available</p>	<p>P</p> <p>P</p> <p>P</p> <p>P</p> <p>P</p> <p>P</p> <p>P</p>

Test characteristics/requirements	Test parameters/results	Findings
<p>Additional requirements for the GS-mark</p> <p>Safety class of gas spring tube DIN 4550 cl. 5</p> <p>Maximum permissible distance "u" between seat front edge and the center of the gas spring in accordance with safety class may not be exceeded.</p> <p>General safety requirements DIN 4550: 2004 cl. 6.1</p> <p>Self-supporting gas springs must have a tripping device on the face side and have to be made of one part in the load bearing area.</p> <p>Gas spring taper DIN 4550 cl. 6.2, 6.3</p> <ul style="list-style-type: none"> - overlapping minimum 80 % - one-piece taper - radius minimum 1 mm at the bottom edge - taper with smooth surface <p>Durability test for self-supporting energized devices DIN 4550 cl. 7.2</p> <p>Test certificate for durability test.</p> <p>Marking of gas spring DIN 4550 cl. 9</p> <ul style="list-style-type: none"> - manufacturer - type designation - classification - date of production (week / year) <p>Safety advice on the chair DIN 4550 cl. 9</p> <p>A conspicuous warning advice near the gas spring in German with the following content: "Achtung! Austausch und Arbeiten im Bereich des Sitzhöhenverstellelementes nur durch eingewiesenes Personal."</p> <p>We recommend the safety advice also in the language of the country in which it will be delivered to the end user.</p> <p>Self assembly EK 5 / AK 3: 01-04</p> <p>The decision of EK 5 / AK 3: 01-04 for self assembly office work chairs shall be considered.</p>	<p>DIN 4550 certificate available</p> <p>DIN 4550 certificate available</p> <p>DIN 4550 certificate available</p> <p>DIN 4550 certificate available</p> <p>DIN 4550 certificate available</p> <p>DIN 4550 certificate available</p> <p>no assembly required</p>	<p>P</p> <p>P</p> <p>P</p> <p>P</p> <p>P</p> <p>P</p> <p>n.a.</p>

Test characteristics/requirements	Test parameters/results	Findings
<p>Marking according to ProdSG section 2 § 6</p> <p>Durable marking of product with name and contact address of manufacturer or importer and the product designation.</p> <p>Materials</p> <p>Materials and its combinations shall not be toxic, among others the following certificates are necessary:</p> <ul style="list-style-type: none"> - test certificate of harmful substances for wooden materials. - test certificates of harmful substances for upholstery and cover materials. - risk analysis for Polycyclic Aromatic Hydrocarbons (PAH) according to the valid ZEK requirement. <p>User information DIN EN 1335-2, cl 5</p> <p>Each chair shall be accompanied by information for use in the language of the country in which it will be delivered to the end user. It shall contain at least the following details:</p> <ul style="list-style-type: none"> a) information regarding the intended use; b) information regarding possible adjustments and chair type (see EN 1335-1:2000); c) instruction for operating the adjusting mechanisms; d) instruction for the care and maintenance of the chair; e) information regarding all adjustments; f) information for chairs with seat height adjustments with energy accumulators that only trained personnel may replace or repair seat height adjustment components with energy accumulators; g) information on the choice of castors in relation to the floor surface. <p>Chemical assessment (PAH)</p>	<p>available</p> <p>requirements fulfilled</p> <p>no wood material</p> <p>available</p> <p>available</p> <p>available</p> <p>Remark 1)</p>	<p>P</p> <p>n.a.</p> <p>P</p> <p>P</p> <p>P</p> <p>P</p>

Remark 1): The accessibility and selection of materials did not result in suspicion regarding a PAH-risk (see document ZEK 01.01-08 of ZLS). Evidences of cover materials / Armrests / Backrest are available at Intertek / Scandinavian Business Seating AS.